

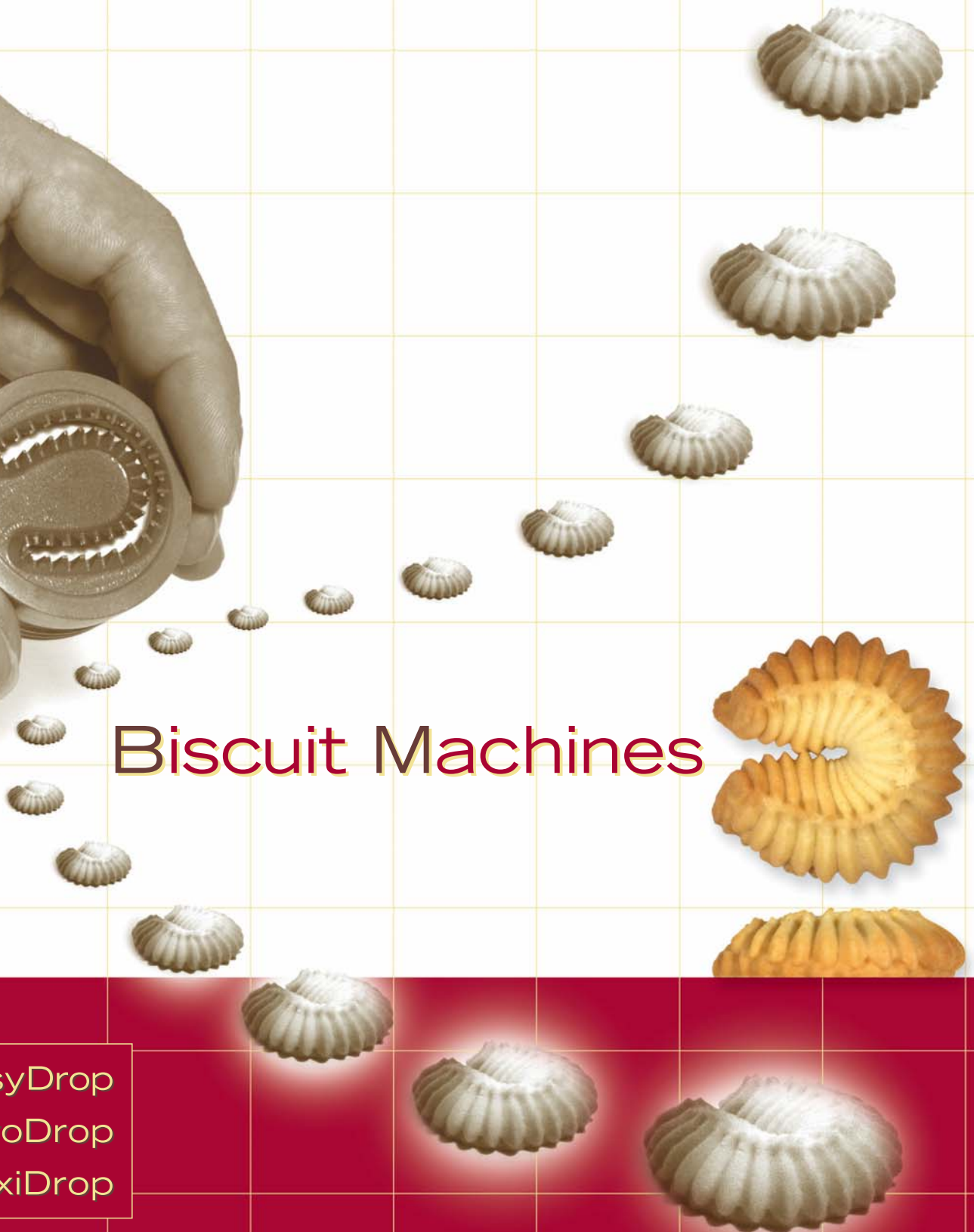

MIMAC

food processing equipment



Biscuit Machines

EasyDrop
EuroDrop
MaxiDrop

the Art of the Biscuits

biscuit machines **DROP**

italiano La ventennale esperienza ed il costante rinnovamento tecnologico hanno collocato la MIMAC ITALIA S.r.l. ai vertici del mercato mondiale nella produzione di macchine dosatrici per la piccola e media pasticceria. I nuovi modelli computerizzati che MIMAC ITALIA S.r.l. propone sono l'avanguardia tecnologica del settore. L'intercambiabilità dei gruppi di dosaggio a rulli e a pompa, la vasta scelta tra stampi fissi e girevoli e le numerosissime forme dei beccucci, consentono di realizzare in modo versatile e creativo ogni tipologia di prodotto. Tutte le parti a contatto alimentare sono costruite con materiale atossico e sono interamente e facilmente smontabili per la pulizia. Praticità di utilizzo, velocità, affidabilità elettronica e robustezza meccanica sono solo alcune delle caratteristiche universalmente riconosciute alle macchine per biscotti di MIMAC ITALIA S.r.l..
Lasciate spazio alla fantasia, al resto ci pensa MIMAC.

english The twenty-years experience and the constant technological renewal have brought MIMAC ITALIA S.r.l. to the top of the world market in the production of dosing machines for the small and medium pastry-making industry. The new computerized models offered by MIMAC ITALIA S.r.l. represent the most advanced technology in the field. The interchangeability of the rolls and pump dosing assemblies, the wide choice among stationary and rotary moulds and the numerous shapes of nozzles allow to create in versatile and creative way any type of product. All parts in contact with foodstuffs are made in non-toxic material and can be entirely and easily removed for cleaning. Use convenience, speed, electronic reliability and mechanical sturdiness are just some of the features universally recognized to the machines for biscuits of MIMAC ITALIA S.r.l..
Let your fancy free, MIMAC thinks about the rest.

français L'expérience de plus de vingt ans et l'innovation technologique constante placent MIMAC ITALIA S.r.l. au sommet du marché dans le monde, pour la production de machines de dosage pour la petite et moyenne pâtisserie. Les nouveaux modèles informatisés que MIMAC ITALIA S.r.l. propose, représentent une technologie avancée dans ce secteur. La possibilité d'échanger les groupes de dosage de rouleaux et pompe, un grand choix entre moules fixes et tournants et les très variées formes des douilles, permettent de réaliser d'une façon très flexible et créative tout type de produit. Toutes les parties en contact alimentaire sont fabriquées avec matériau atoxique et sont totalement et aisément démontables pour le nettoyage.
Un emploi pratique, vitesse, fiabilité électronique et robustesse mécanique sont quelques des caractéristiques universellement reconnues aux machines pour biscuits de MIMAC ITALIA S.r.l..
Laissez de l'espace à l'imagination, MIMAC pense au reste.



EasyDrop
EuroDrop



EasyDrop Inox
EuroDrop Inox





EuroDrop TF Inox



EuroDrop TF 600



MaxiDrop 400



MaxiDrop 600

deutsch

Die zwanzigjährige Erfahrung und die ständige technologische Erneuerung stellen MIMAC ITALIA S.r.l. an der Spitze des Weltmarktes in der Erzeugung von Dosiermaschinen für die kleine und mittelständige Konditoreiindustrie. Die neuen computerisierten Modelle, die MIMAC ITALIA S.r.l. anbietet, stellen die fortgeschrittenste Technologie vom Zweig dar. Die Austauschbarkeit der Rollen und Pumpendosiergruppen, die breite Auswahl unter festen und drehenden Formen und die zahlreichen Formen der Tüllen gestatten es auf vielseitige und schöpferische Weise jede Art von Produkten zu erzeugen. Alle Teile, die in Berührung mit Nahrungsmitteln kommen, sind aus atoxischem Material hergestellt und können vollkommen und einfach für die Reinigung ausgebaut werden. Gebrauchszweckmäßigkeit, Geschwindigkeit, elektronische Zuverlässigkeit und mechanische Robustheit sind nur einige der allgemein an den Maschinen für Keksen“ von MIMAC ITALIA S.r.l. anerkannten Eigenschaften. Lassen Sie freien Lauf ihrer Phantasie - an den Rest denkt MIMAC.

español

La experiencia de veinte años y la constante innovación tecnológica han colocado MIMAC ITALIA S.r.l. al tope del mercado mundial en la producción de máquinas dosificadoras para la pequeña y media pastelería. Los nuevos modelos computerizados que MIMAC ITALIA S.r.l. propone representan una tecnología avanzada en el sector. La posibilidad de intercambiar los grupos de dosificación de rodillos y bomba, la vasta selección entre moldes fijos y giratorios y las muy numerosas formas de las boquillas, permiten de realizar de manera flexible y creativa toda tipología de producto. Todas las partes en contacto alimenticio están construidas con material atóxico y son totalmente y fácilmente desmontables para la limpieza. Practicidad en el empleo, velocidad, fiabilidad electrónica y robusteza mecánica son solo algunas de las características universalmente reconocidas a las máquinas para biscochos de MIMAC ITALIA S.r.l.. Dejen espacio a la fantasía, MIMAC se ocupa de todo.



Gruppi di dosaggio

Dosing units - Groupes de dosage - Dosiergruppen - Grupos de dosificación



Testata a Rulli
Roller head
Tête à rouleaux
Rollenkopf
Cabezal de rodillos



Testata a Pompa
Pump head
Tête à pompe
Pumpenkopf
Cabezal de bomba

Accessori

Accessories - Accessoires - Zubehöre - Accesorios



Stampi
Moulds
Moules
Formen
Moldes

Stampi per taglio a filo
Wire-cut moulds
Moules pour coupe au fil
Drahtschnittformen
Moldes para corte de alambre

Telaino e stampo per taglio a filo
Frame and wire-cut mould
Cadre et moule pour coupe au fil
Rahmen und Drahtschnittform
Chasis y molde para corte de alambre

Tipologie ed applicazioni

Typologies and applications - Typologies et applications
 Typologien und Anwendungen - Tipologías y aplicaciones



Stampo Fisso



Stationary mould - Moule fixe
Fester Form - Molde fijo



Stampo Girevole



Rotary mould - Moule tournant
Drehbarer Form - Molde giratorio



R1



R2



R3



R4



R5



R6

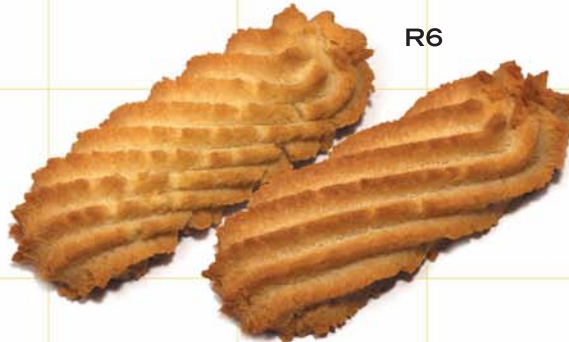

R7

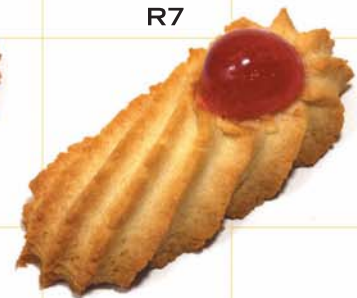

R8



R9



R10



R11



R12



R13

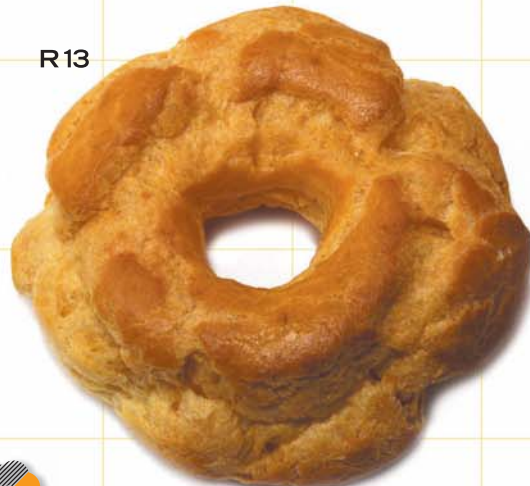

Stampo Fisso

Stationary mould - Moule fixe
Fester Form - Molde fijo



F1



F2



F3



F4



F5



F6



F7



F8



F9



F10



F11



F12



F13



F14



F15



F16



Beccucci Figurati

Multiple nozzles - Douilles figurées
Bildtüllen - Boquillas figuradas



F17



F18



F19



F20



F21



F22



F23



F24



F25



F26



F27



F28



F29



F30



F31



F32





T1



T2



T3



T4



T5

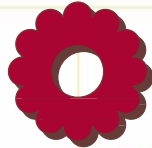

T5/2



T6



T6/2



T7



T8



T9



T10



T11



T12

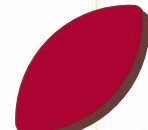

T13

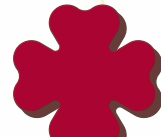

T14



T6



T12



T5



T5/2

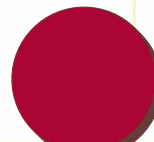

T6



T6/2



Testata a Pompa

Pump head - Tête à pompe
 Pumpenkopft - Cabezal de bomba

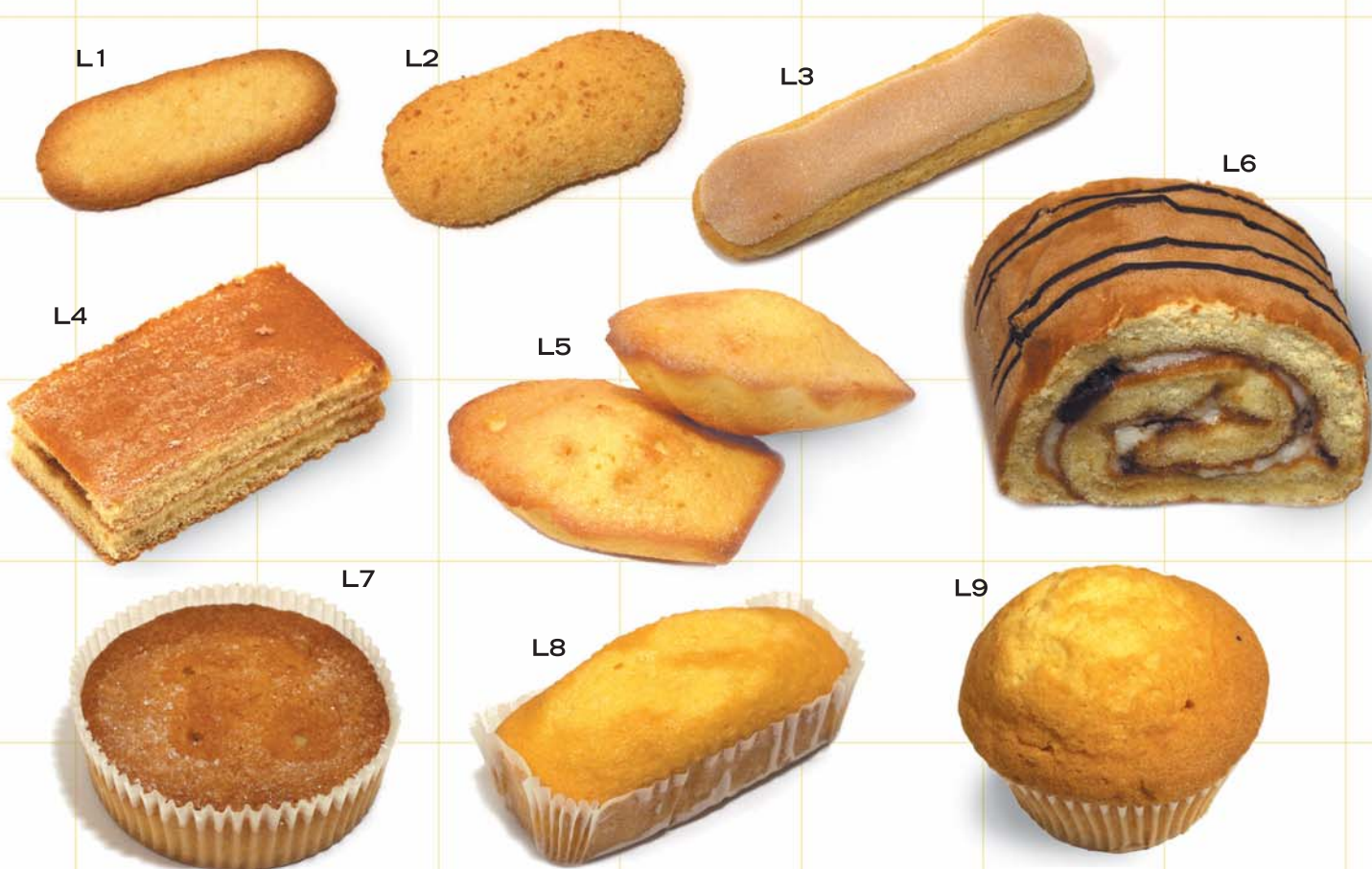

Prodotti con MaxiDrop SX

Products by MaxiDrop SX - Produits par MaxiDrop SX
 Produkte mit MaxiDrop SX - Productos por MaxiDrop SX



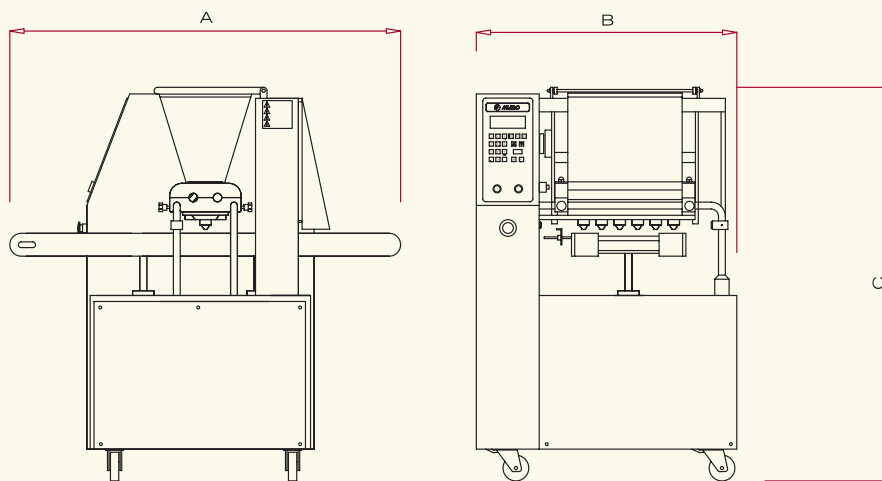

CARATTERISTICHE TECNICHE - TECHNICAL SPECIFICATIONS
 CARACTERISTIQUES TECHNIQUES - TECHNISCHE KENNZEICHEN - CARACTERÍSTICAS TÉCNICAS

Modello Model Modèle Modell Modelo	Teglie Trays Plaques Bleche Bandejas (mm)	A (mm)	B (mm)	C (mm)	Peso Weight Poids Gewicht Peso (kg)	Potenza Power Puissance Leistung Potencia (kW)
EASYDROP 400/450	400/450	1350	950	1380	280	1
EASYDROP 600	600	1350	1150	1380	300	1
EURODROP 400/450	400/450	1350	950	1380	280 ÷ 350	1÷1,5
EURODROP 600	600	1350	1150	1380	300 ÷ 380	1÷1,5
MAXIDROP 400/450	400/450	1350	950	1380	350	1,5
MAXIDROP 600	600	1350	1150	1380	380	1,5

MIMAC ITALIA S.R.L. si riserva di apportare eventuali modifiche tecniche e costruttive. - MIMAC ITALIA S.R.L. reserves the right to make any technical and structural modification.
 MIMAC ITALIA S.R.L. se réserve le droit d'apporter éventuelles modifications techniques et de construction. - MIMAC ITALIA S.R.L. behält sich vor technische und bauliche Änderungen vorzunehmen.
 MIMAC ITALIA S.R.L. se reserva la facultad de aportar eventuales modificaciones técnicas y constructivas.

*Decorazioni, guarniture ed accoppiamenti sono fatti a mano. Savoïardi, madeleines e plum-cakes sono colati in teglie opportunamente stampate.
 Topping, dressing and stacking are made by hand. Lady-fingers, madeleines and plum-cakes are dropped on suitable moulded trays.*

Décorations, garnitures ed combinaisons sont faites à la main. Biscuits à la cuiller, madeleines et plum-cakes sont dosés en plaques préformées.

*Die Verzierungen und die Verbindungen von zwei Produkten werden handgefertigt. Löffelbiskuite, Madeleines und Sandkuchen werden auf passende vorgebildete Kuchenformen gespritzt.
 Decoraciones, guarniciones y uniones de productos son hechas a mano. Galletas de Saboya, magdalenas y plum-cake son dosificados en bandejas moldeadas.*



Agency:

MIMAC ITALIA s.r.l.
 Via dell'Industria, 22
36013 PIOVENE ROCCHETTE (VI)
 Tel. 0445.576250 - Fax 0445.576112
 info@mimac.com